

アルミ枠

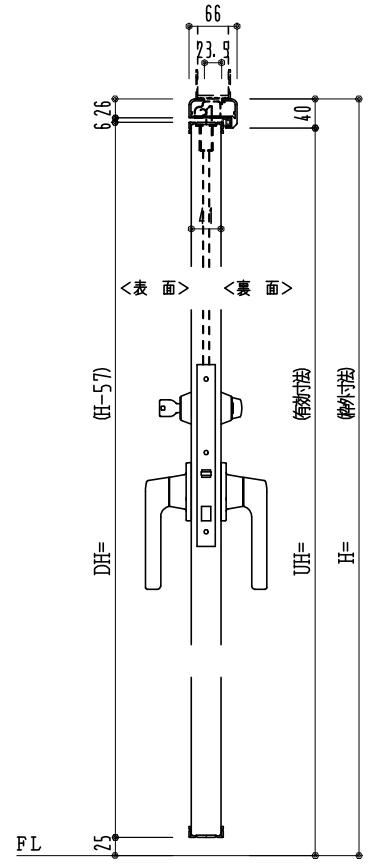
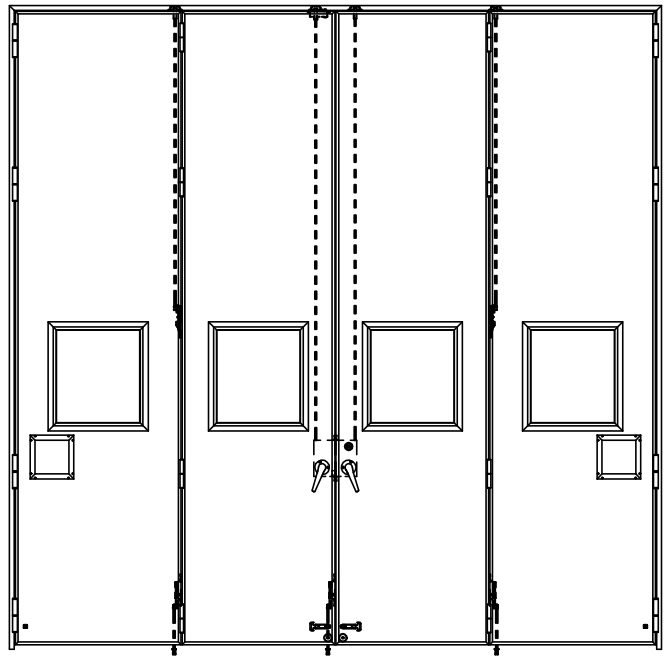
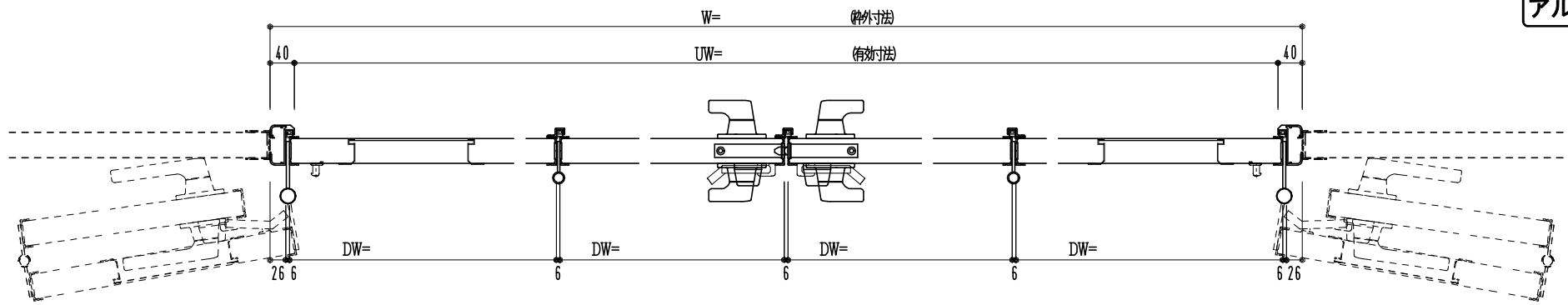

作 図 縮 尺	
正面図	1 / 1
水平断面図	3 / 1
垂直断面図	3 / 1