

アルミ枠

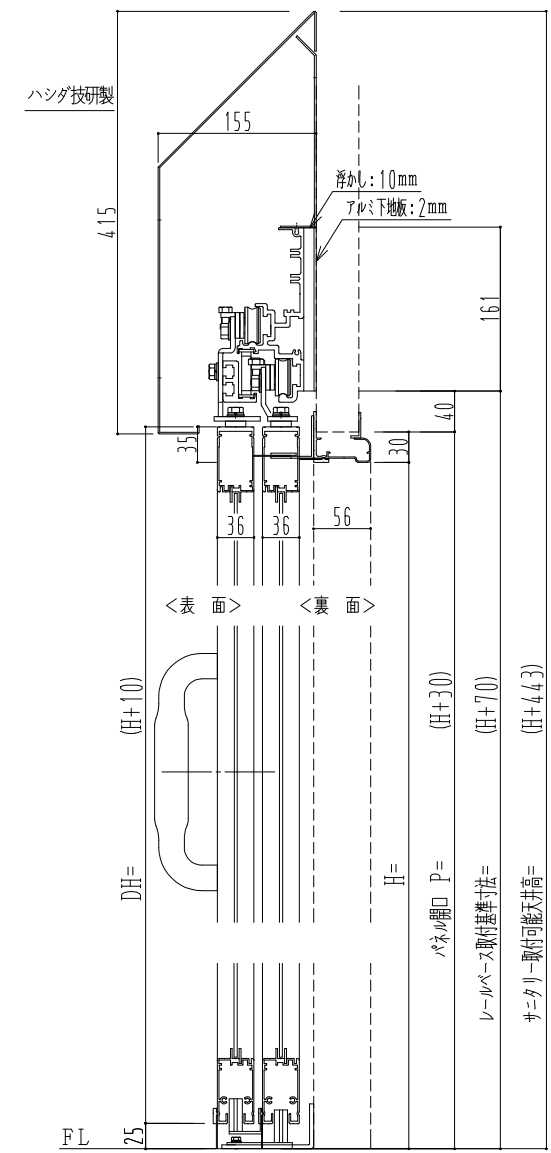
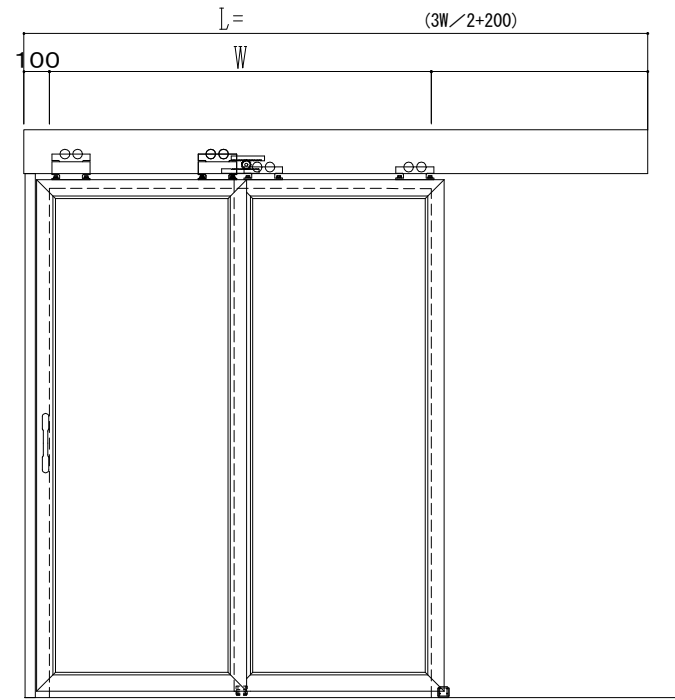
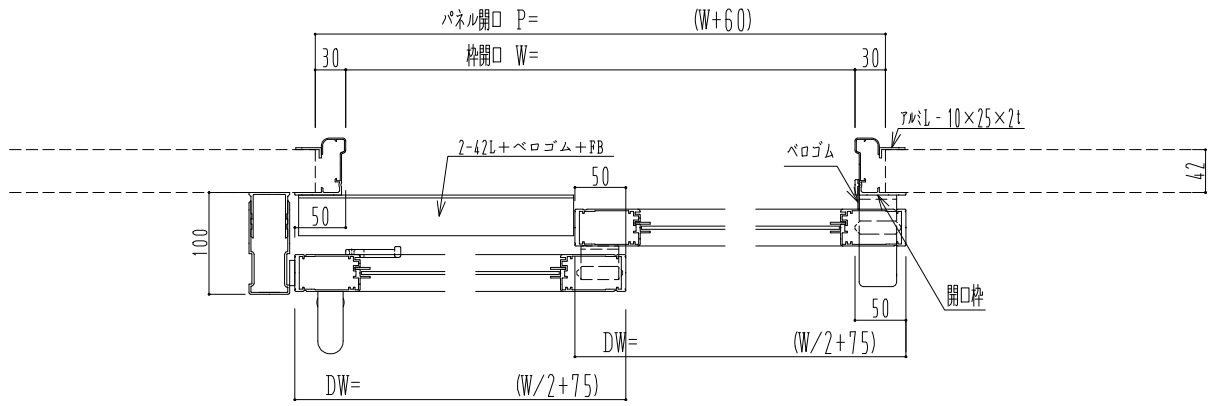

| 作図縮尺  |       |
|-------|-------|
| 正面図   | 1 / 1 |
| 水平断面図 | 5 / 1 |
| 垂直断面図 | 5 / 1 |