

アルミ枠

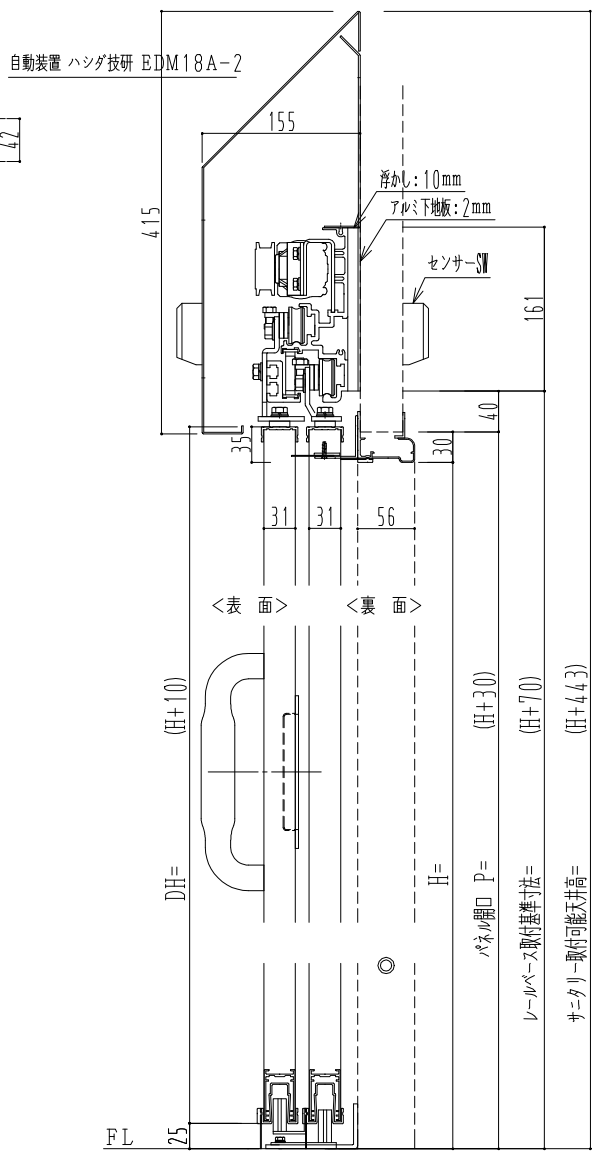
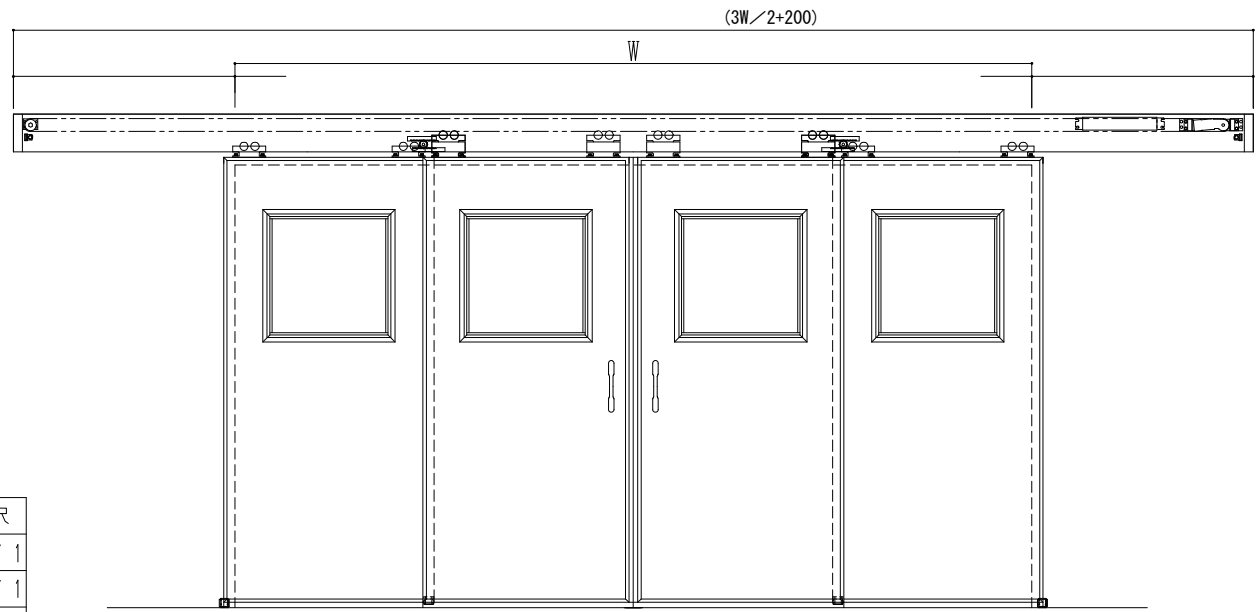
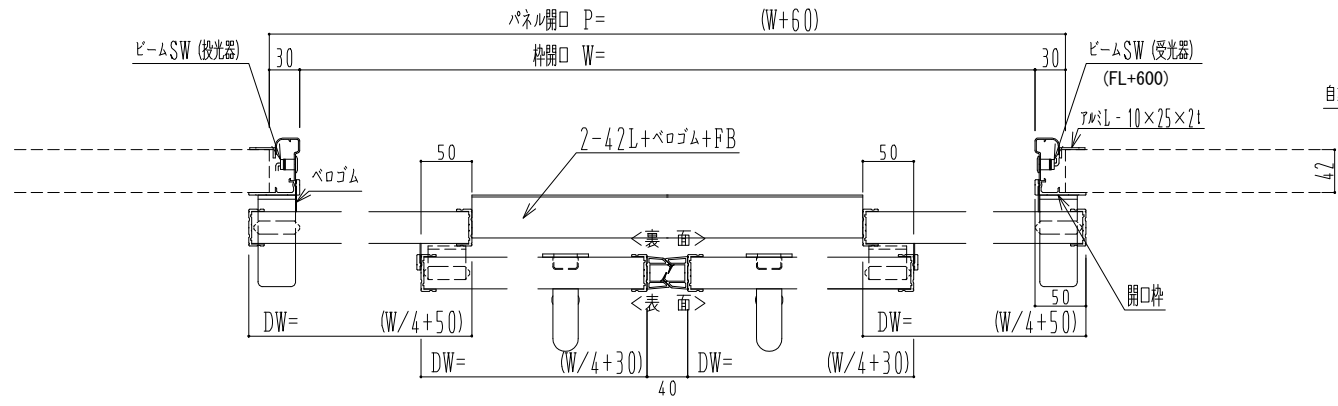

作図縮尺	
正面図	1 / 1
水平断面図	5 / 1
垂直断面図	5 / 1